

Evidence Digital

Modernity of an active heat convector equipped with user-friendly digital display

Characteristics

- ▶ High precision digital display enabling room temperature easy reading
- ▶ Up to 20% energy savings* through finest digital control and programming
- ▶ Fitted with plug and standing kit (option)

Comfort

- Quick heat-up time
- High-precision electronic thermostat
- Sheathed heating element with an aluminium diffuser (safe, silent and long-lasting)
- Model with plug and standing kit (option)

Savings

- Built-in On/Off timer function
- Electronic thermostat (comfort, energy savings, high quality)

User-friendliness

- 4 modes switch: Comfort, Eco, Frost-free, On/Off timer
- Easy access digital display unit showing the temperature in degrees
- Easy to install: H-shaped vertical support, which can also be used as an installation template





Design

- French life-style design
- Automatic over-heating safety device
- Dual electric insulation for ultimate safety
- Front air outlet
- Colour shade: white (RAL 9016)



Standard

Easy to install

Models available**  1 2 3 4	Output ACTIVE HEAT CONVECTOR 500 TO 2000 W	Energy savings 
Controls  Digital controls	Technology 	Heating element type 

Water Heating
Heating
Ventilation
Heat Pumps

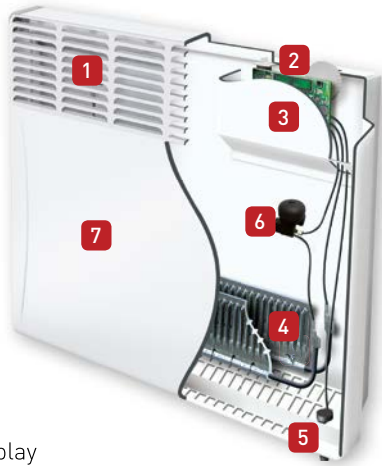

- 1 Air outlet
- 2 Digital display
- 3 Over-heating safety device
- 4 Sheathed heating element with aluminium diffuser
- 5 Room temperature sensor
- 6 Anti-fall down system
- 7 Front panel

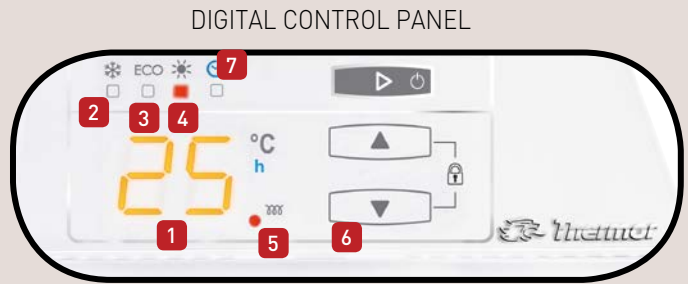

- 1 Display
- 2 Anti-frost mode
- 3 Economy mode
- 4 Comfort mode
- 5 Heating light indicator
- 6 Temperature settings
- 7 ON-OFF Timer

Compatible
with standing kit*



*Optional, to be purchased separately

Installation dimensions (in mm)

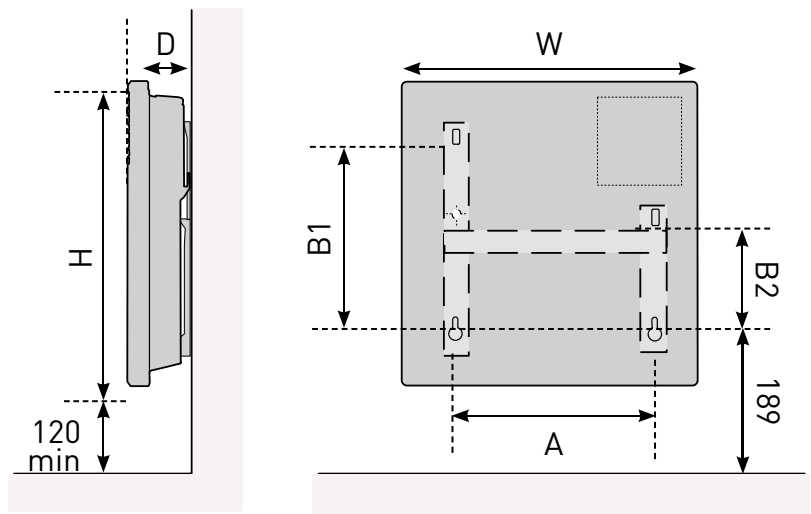

EVIDENCE DIGITAL

Technical data

Output (W)	Dimensions (mm)						Net weight (kg)
	Width (W)	Height (H)	Depth (D)	A	B1	B2	
500	384	451	98	195	256	158	2.9
1000	458	451	98	269	256	158	3.2
1500	606	451	98	343	256	158	4.4
2000	754	451	98	491	256	158	5.2

